

APPLICATION NOTE

Tone Assessment using the 2260H Sound Level Analyzer



This application note presents a case and explains the concepts and features of tone assessment in Sound Level Analyzer Type 2260H. The description is based on the JNM2 method, since this is the de facto standard and the one specified in most detail. For computer-based tone assessment, the JNM2 method includes guidelines which are implemented in Type 2260H.

JNM2 is an abbreviation of Joint Nordic Method version 2. The method is being included in national (e.g., DIN) and international (ISO) standards.

The features of other standards are also discussed and compared to JNM2.

Two cases are presented, using the ISO and DIN standards respectively.

2260 H

Contents

Case 1 – Cooling Fans	3
The Problem	3
List of Equipment	3
Setup	4
Measurement	4
Results	5
Conclusions	6
Case 2 – Water Pumps	6
The Problem	6
Equipment	6
Setup	6
Measurement	7
Results	7
Conclusions	9
Concepts	9
Standards for Tone Assessment	9
The Role of Tone Assessment	10
Tone Assessment Procedure	10
Special Tones	11
Audibility	11
Masking	12
Masking Noise Level	12
Critical Band	13
Measurements	13
Setup	13
Measurement Span	14
Default Setups	14
Aural Monitoring	15
Sound Recording	15
Calculations	15
Adding up the Lines of Tones	16
Audibility	17
Penalty	17
Example 1	17
Example 2	17
Results	18
Result Parameters	18
Classification codes	19
Critical band details	19
Most prominent tone	19
Improving Results	19
Setup requirements	21
Report	22
For the analysis	22
For the calculations in the decisive critical band	22
Standards	23
Examples	26
Broadband Overview	26
Adjusting Span and Averaging Time	27
Zooming in	27
Final results	28
Appendix: Sound Recording	29
Sound Recording on a PC	29
Recording Sound on a DAT Recorder	31
Recording Sound on a PC from DAT Recordings	31
Playing Back Sound into Type 2260 H	31

Case 1 – Cooling Fans

For tutorial purposes, a typical situation is presented, and the measurements and conclusions do not represent any actual situation.

The Problem

A large production plant is located next to a dwelling area, and arrays of cooling fans are installed close to the fence between plant and dwellings (see Fig. 1 and Fig. 2). For the dwelling area, up to 45 dB L_{Aeq} is allowed during the daytime, and up to 40 dB L_{Aeq} during the night. The L_{Aeq} has been measured during the day and during the night, and is below the limit values. The investigators have noted that tones from the fans are indeed audible, but the problem is: what penalty should be assigned to the noise due to its tonal quality?

Fig. 1
Chemical plant with horizontal (close to fence) and vertical (on building) arrays of cooling fans



List of Equipment

Basically, all you need for tone assessment is Sound Level Analyzer Type 2260 H, but the following should be considered:

- Windshield UA 0237
- Sound Level Calibrator Type 4231 – for documentation and for sound recording reference
- Tripod UA 0801 – for longer-duration measurements
- Sound recording equipment (DAT or PC) – for documentation and later analysis
- Earphone HT 0015 and Headphone Adaptor AO 0522 – for subjective confirmation of tone
- Camera – for documentation
- GPS – for documentation – the GPS position data can be transferred to and stored in Type 2260 H

Fig. 2
*Cooling fans
located close to the
fence of
neighbouring
dwellings*



Fig. 3
*Measuring fan
noise at the fence*



Setup

Type 2260 H was placed at the fence at a height of 1.5 m, as prescribed in the national guidelines. Wind speed was low, and no precipitation was observed. The distance to the nearest cooling fan array was about 15 m, and about 50 m to the farthest array.

Measurements were made in representative modes of operation for the fans. DAT recordings were made for documentation. A suburban railway line was located in the vicinity, and care was taken not to include any train noise in the measurements.

Measurement

Listening to the fans operating, the sound from the fan blades appeared to be broad-band, but some noise of a tonal character was audible from the pump systems. This was confirmed using the “live” display in Type 2260 H (Exponential averaging), with spans and centre frequencies as given in the Default Setup section. Using Setup 1 (0 – 1260 Hz span) and Linear averaging, the spectrum was measured to assess the pump tones. To confirm the objective findings, the built-in tone generator of Type 2260 H was used, presenting the microphone signal mixed with a generated tone at the cursor frequency (see Aural Monitoring on page 15).

When the fans were turned off, all was quiet until the fans were almost at standstill. Then for a 5 second period, each of them emitted a siren-like wail until all eventually stopped. Since the

fans did not stop at the same instant, a sequence of partially overlapping wails was heard. The frequency of each wail varied, and this was obvious in the spectrum when using Exponential averaging. To assess the tones during fan run-down, logging was used, with 0.5 s periods and Linear averaging. The span was set as indicated in Default Setups on page 14, Setup 2 (1000 – 3500 Hz).

Results

Tone assessment was made according to the ISO standard.

While the cooling fans operate, the noise has pronounced tones at 302, 433, 596 and 615 Hz. Out of these, the 596 Hz tone is the most prominent, with a tone level of 54.5 dB. A second, less audible, tone is present within the same critical band, at 615 Hz with a tone level of 52.4 dB. For this decisive critical band, the resulting tone audibility is 7.9 dB and the associated penalty is 3.9 dB.

To further investigate the peaks, the Harmonic cursor was used to find possible harmonic relations. A weak 145 Hz fundamental was found, with harmonics at 436, 583 and 1166 Hz. These do not include the most prominent tone, so we probably have more than one source of tones.

Fig. 4

a) Cooling fans operating – tone assessment: most prominent tone indicated by *T

b) Cooling fans operating – tone assessment: second tone in same critical band (display expanded)

c) Cooling fans operating – details of the most prominent tone

d) Cooling fans operating – analysis using harmonic cursor, 145 Hz fundamental

e) Cooling fans run-down – wail averaged over 5 s

f) Cooling fans run-down – wail logged in 0.5 s periods, one period shown

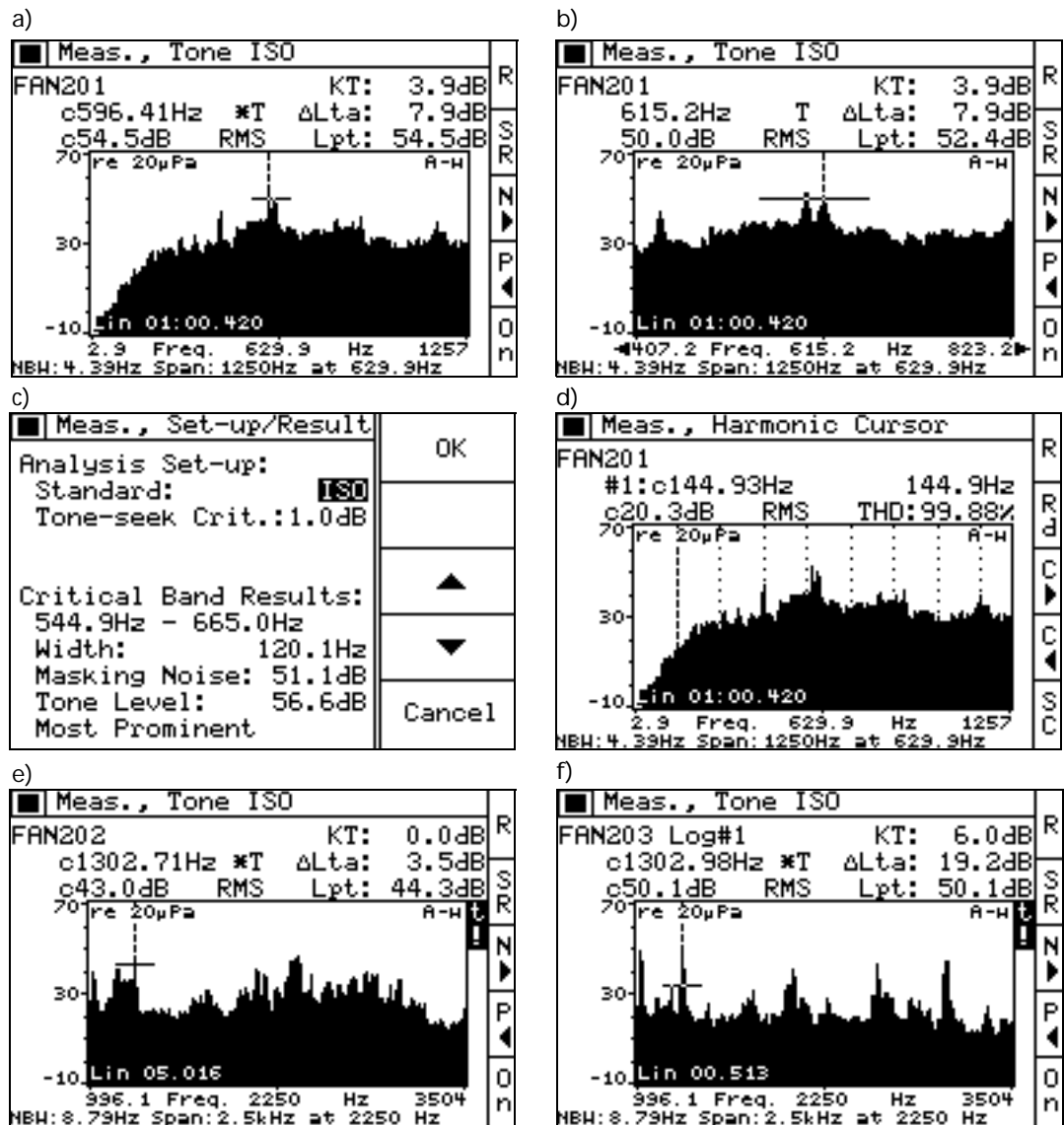

During fan run-down, averaging over the run-down showed low tone audibility (3.5 dB and no penalty for the most prominent tone). However, logging reveals pronounced tones at time-varying frequencies. One of the logging periods is shown (Fig. 4f), with a most prominent tone at 1303 Hz. The audibility is 19.2 dB and the associated penalty is 6.0 dB.

Conclusions

- Tone assessment was made for the noise from cooling fans at a large production plant
- During operation of the fans, a 596 Hz tone is the most prominent and carries a penalty of 3.9 dB
- When the fans are stopped, during the run-down, they emit a wail for 5 seconds, with varying frequency in the 2 kHz range and high audibility, leading to a calculated penalty of 6 dB
- The penalties for the “Operate” and “Run down” modes can now be added to the L_{Aeq} , taking into account their duration and time of day.

Fig. 5

There are times when you should not measure, for example when a suburban train is passing in the vicinity



Case 2 – Water Pumps

The Problem

Fig. 6

Typical high power water pump – rated at 1.5 kW and 4 m³/hour



A pump manufacturer wants to improve the sound of his products, and to compare the sound of his own and competitors' products. The manufacturer suspects that the tonal character of the sound is an important factor when assessing the sound quality. To investigate this issue, tone assessment is made to compare pumps of different manufacture but similar power, under identical operating conditions.

Equipment

All you need for tone assessment is Type 2260 H, but a tripod can be helpful.

Setup

The pumps were set up in a semi-anechoic room, typical of installations in practice. The pump instal-

lation and load was standard. Type 2260 H was placed at ½ m meter distance, typical of a technician doing service and listening to the pump.

Measurement

Fig. 7
Preparing for measurement



Tone assessment was made for each pump according to the DIN standard. 1 minute Linear averaging and A-weighting was used. DIN specifies no frequency weighting, but Type 2260 H corrects this in the tone assessment. For a quick overview, measurement was paused after a few seconds and tone assessment made, to check if any codes in the display (other than “t”) would indicate that a change in setup was needed. The tone found in the tone assessment was confirmed subjectively by listening to the pump signal mixed with the built-in generator signal.

Results

For each pump, the resulting tone assessment spectrum is shown in Fig. 8, with the cursor located at the most audible tone.

Fig. 8
Top left to bottom right: Tone assessment spectra for pumps 1 to 14

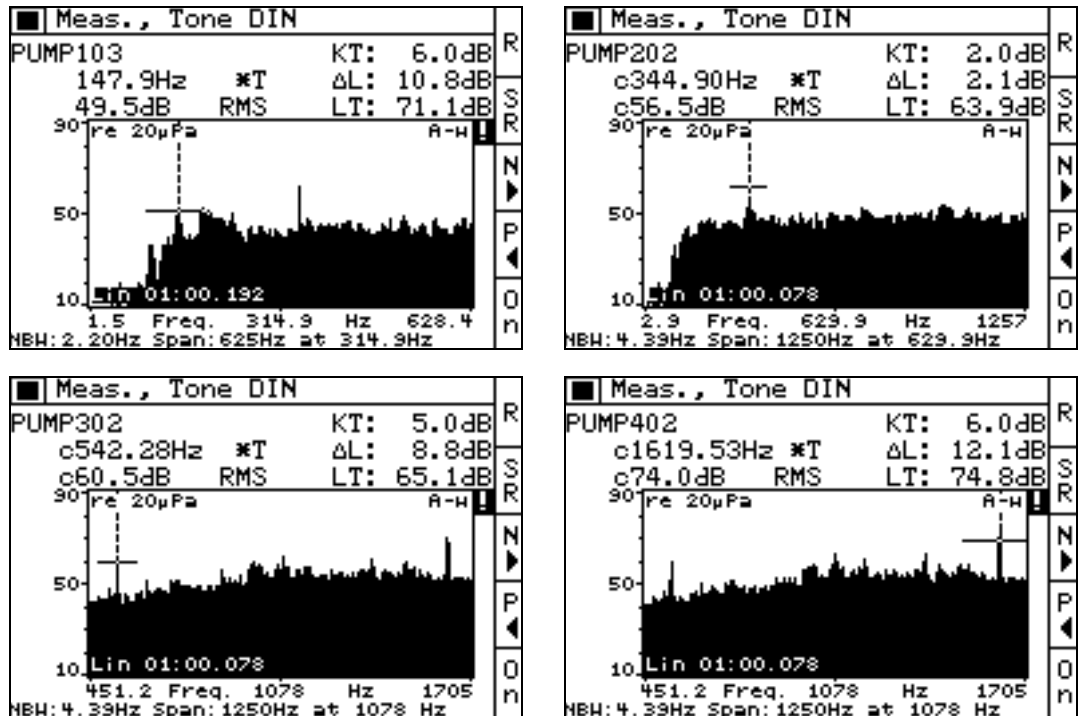
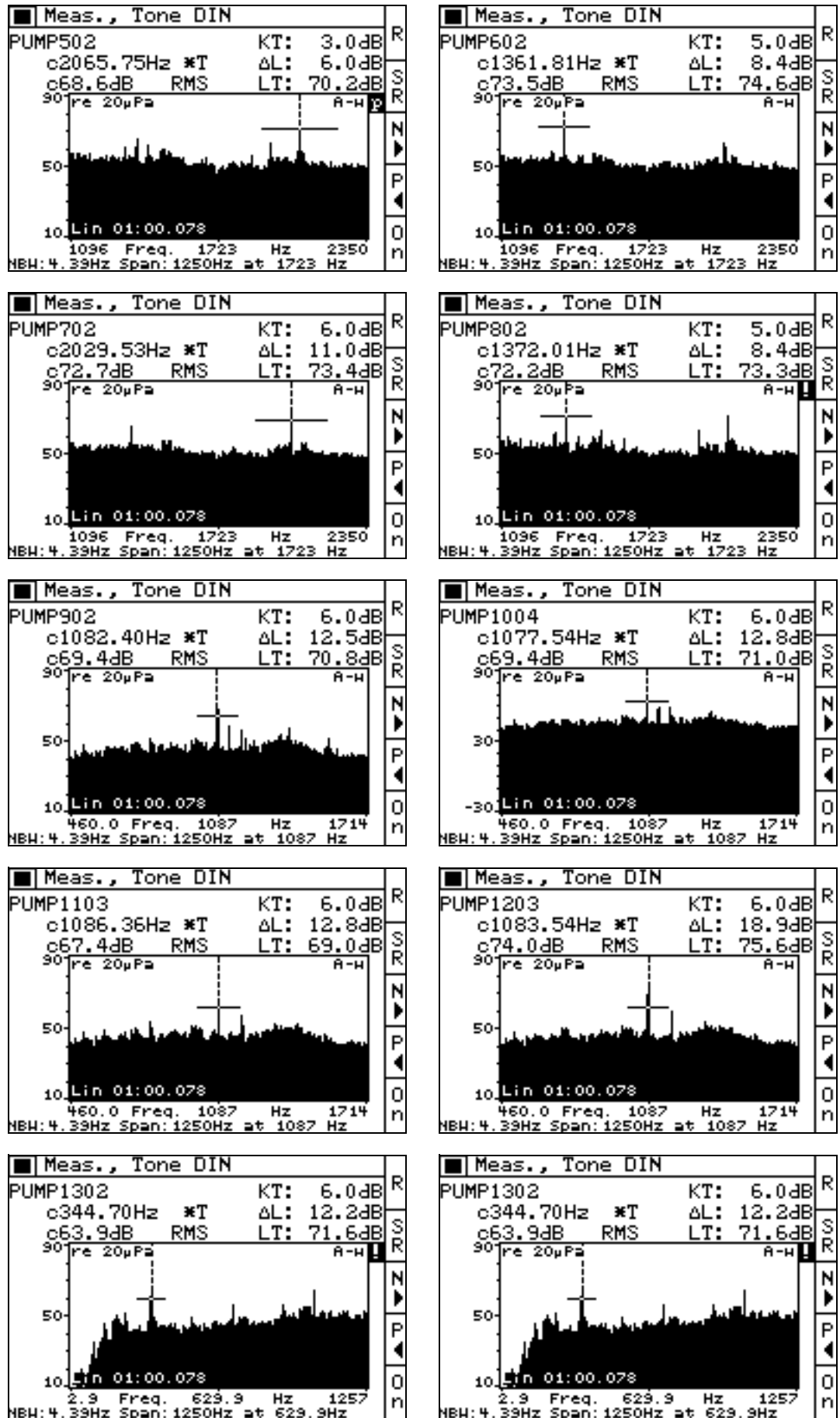

Fig. 8 (cont.)



Conclusions

The tone audibilities for 14 water pumps have been assessed and ranked, as shown in. The pumps have been sorted by Audibility and by tone frequency.

It is evident that the pumps vary widely in tone audibility as well as tone frequency. For the “best” pumps, the tone is only slightly audible (KT = 2.1 dB), while for the “worst” units, the audibility is 18.9 dB. Clearly there is room for improvement, and the vibration measurement capabilities of the 2260 H could be used to pinpoint the sources of tonal noise.

Table 1

Results Ranked by Audibility			Results Ranked by Tone Frequency		
Pump No.	Most Audible Tone		Pump No.	Most Audible Tone	
	Frequency (Hz)	Audibility (dB)		Frequency (Hz)	Audibility (dB)
2	345	2.1	1	148	10.8
14	343	3.5	14	343	3.5
5	2066	6.0	2	345	2.1
6	1362	8.4	13	345	12.2
8	1372	8.4	3	542	8.8
3	542	8.8	10	1078	12.8
1	148	10.8	9	1082	12.5
7	2030	11.0	12	1084	18.9
4	1620	12.1	11	1086	12.8
13	345	12.2	6	1362	8.4
9	1082	12.5	8	1372	8.4
10	1078	12.8	4	1620	12.1
11	1086	12.8	7	2030	11.0
12	1084	18.9	5	2066	6.0

Concepts

Standards for Tone Assessment

Some standards (BS 7445, DIN 45465, Italian Law 447/95, ISO 996–2:1987, NFS 31-010) include objective tone assessment based on 1/3-octave spectra. The level of the tone is compared to that of its neighbour(s), and a penalty assigned if the difference exceeds a specified amount. The assessment in these standards is implemented in the 7820 Evaluator PC software.

This approach is satisfactory when the frequency of interest is above 500 Hz. However, at frequencies below 500 Hz the criterion is too severe. It is possible that at low frequencies, a tone may be identified when none is audible. Also, for complex spectra (as encountered, for example, in wind turbine noise), the approach does not work.

The shortcomings of the 1/3-octave methods are avoided in methods based on FFT, such as BS 7135, DIN 45681 (1992 Draft, TA-Lärm), ISO/CD 1996–2 (2001-05) and the Joint Nordic Method (Version 2, 1999). An overview is given in the Final Report of the Working Group on Noise from Wind Turbines, ETSU-R-97. These methods determine audibility of tones using the Zwicker concept of masking and critical bands. According to Zwicker, only noise within the critical band can mask the tone and thus determines audibility.

The penalty determined using 1/3-octave methods is a fixed number (like 5 dB) while the DIN, ISO and JNM methods use smaller steps (like 0.1 or 1 dB). The smaller steps make sense in cases where there is some doubt to the audibility.

Today, each country still uses its own current method, but the future looks set to recommend FFT as the engineering method and a 1/3-octave method as the survey method with both being acceptable for future national standards. However, the Nordic countries have long used the FFT and Germany has gone over to it in 1998. Probably other countries will follow – some more quickly than others.

The Role of Tone Assessment

Tone assessment is an objective method to rate the annoyance of tones. The aim is to achieve equivalent results to those obtained from the average subjective listener. The JNM2 tone assessment method is based on narrow-band frequency analysis and is widely accepted as proven and accurate for a wide range of sounds in the environment.

Noise in the environment is usually quantified in terms of L_{Aeq} , the A-weighted energy equivalent sound pressure level. If the noise includes an audible tone, this will make the noise more annoying than indicated by the L_{Aeq} . The extra annoyance caused by the tone is accounted for by adding a penalty to the L_{Aeq} . The penalty depends on the audibility and is usually in the range of 0 to 6 dB.

A tone is defined as a maximum in the spectrum that is high enough and narrow enough to be audible as a tone. In the JNM2 standard, “High enough” means more than 6 dB above the surrounding frequency spectrum; “Narrow enough” means the tone must have a 3 dB bandwidth less than 10% of the width of the surrounding critical band (see Critical Band on page 13). This definition also includes narrow bands of noise.

Tone Assessment Procedure

The procedure has three main steps:

1. Analyse the noise at the receiver locations using FFT.
2. Determine the sound pressure level of the tone(s) and the sound pressure level of the masking noise within the critical band.
3. From the difference between tone and masking level, determine audibility and consequently the tonal penalty.

Fig. 9
Overview of tone assessment procedure

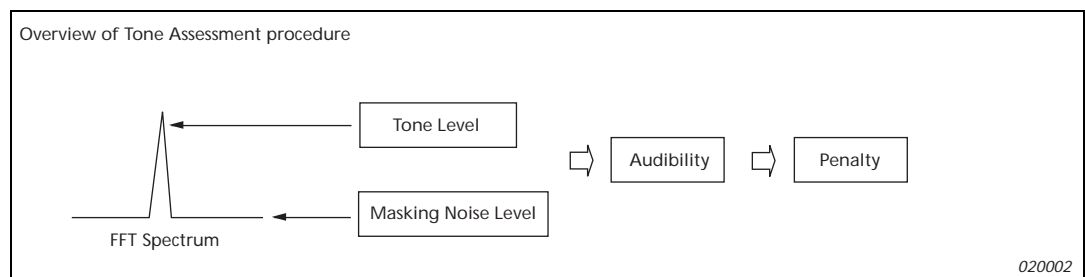

The FFT spectrum is measured (in the JNM2 standard) using the following setup:

- A-weighting
- Linear time averaging
- Frequency resolution of 5% or better of the critical bandwidth
- Hanning time window with at least 67% overlap
- Total averaging time of at least 1 minute

A-weighting has been found to improve tone assessment accuracy in the low-frequency range.

If the spectrum has been measured with no A-weighting, the A-weighting can be applied to the measured spectrum as a post-processing feature.

Special Tones

If several tones are found within one critical band, the total tone level L_{pt} in that band is the energy sum of the individual tone levels.

If the tone frequency varies over the averaging time, its FFT spectrum will get smeared. If the tone varies by more than 10% of the critical bandwidth, the tone-see algorithm will not find the proper results. The averaging time can then be subdivided and the tone level found as the energy average of the tone levels found in the short-term spectra.

Fig. 10
Left: 5 s average of varying tone
Right: 0.5 s part of same sound showing tones

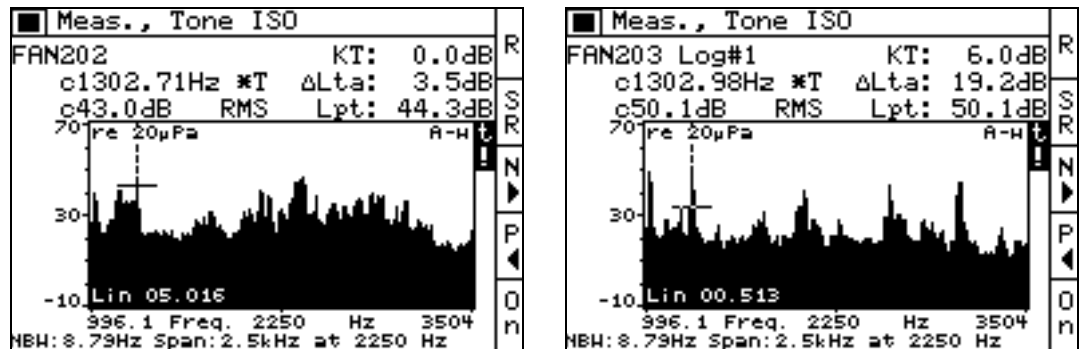

In rare cases with many closely spaced tone components, a finer resolution than the standard 5% of critical band may be needed to determine the level of the masking noise correctly. In the 2260 H/BZ 7208, a “p” code is used to show this condition, which can be remedied by zooming in. (For the meaning of the “p” code, please see Results on page 18).

If the tone is very prominent, such as the tone from a calibrator or the tone from a piano (low background noise), the tone assessment calculation may not identify it as a tone. The frequency spectrum for this kind of tone looks like a narrow bell, with no “flat” sections to allow determination of the masking noise level. No masking noise lines are found within the critical band, so the tone assessment cannot proceed. This condition is indicated by a “N” code in the display, and the cure is to increase the tone-see criterion (mentioned later – it can be increased from the default 1 dB up to 4.0 dB) or to zoom in. See Fig. 11.

Audibility

A just-audible tone will appear as a local maximum of 8 dB above the surrounding masking noise. This assumes a certain frequency resolution (see Default Setups on page 14).

The FFT analysis can show tones that are inaudible – by zooming in on a tone, the masking noise level will seem to drop (by a factor of $10 \log$ (the zoom ratio) - i.e., $3 \text{ dB per } \times 2 \text{ zoom}$). Thus by zooming in from maximum span to minimum span, the masking noise level will seem to have dropped by $10 \log 27 = 10 \log 128 = 21 \text{ dB}$, which can very well reveal a “tone” that is not at all audible. The Tone Assessment will then give the audibility as a negative number.

In addition, the tone can be too weak to be heard at all, if it is below the hearing threshold. This is most likely to occur at low frequencies because of the elevated threshold in this region. If the total tone level in a critical band is below the hearing threshold, this critical band shall be disregarded in the assessment of tone audibility. Hearing thresholds are defined in ISO 226, 1987.

Fig. 11

a) Assessment of a very prominent tone (from calibrator) did not find the 1 kHz tone

b) ... but by changing the Tone Seek Criterion from 1 to 3 dB ...

c) ... the calibrator tone is found. However, a better way is to zoom in ...

d) and by zooming in, the 1 kHz tone is correctly found

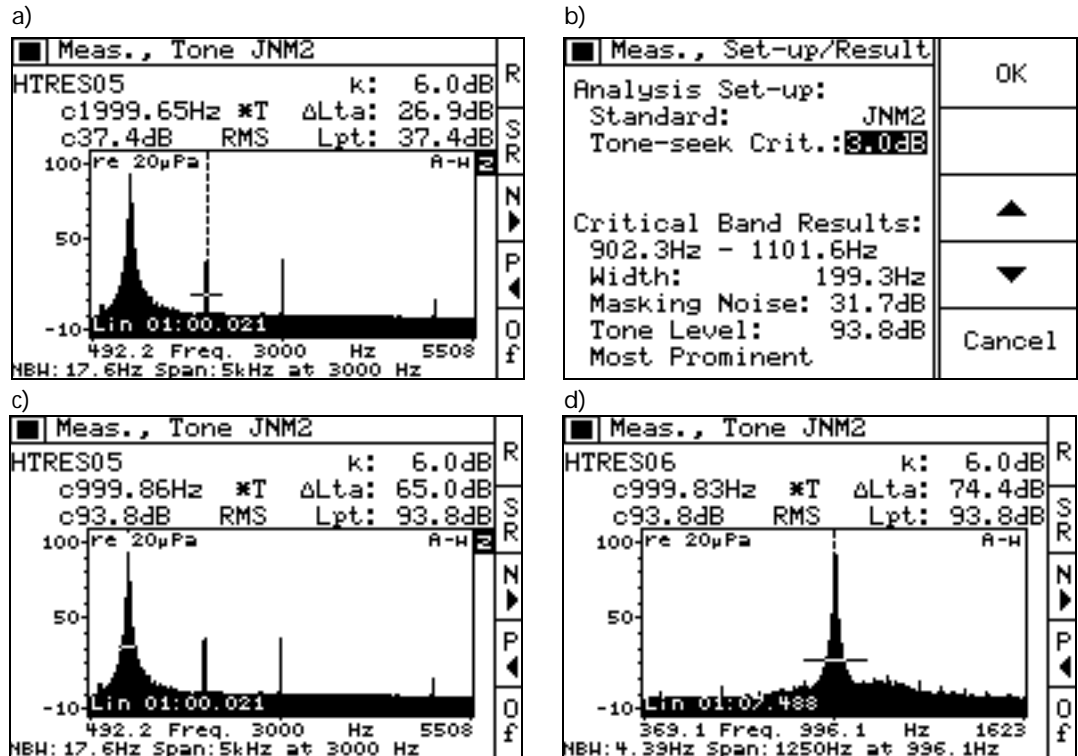

On the other hand, the FFT may fail to show an audible tone, if the FFT resolution is too coarse. Then the tone is not visible in the spectrum. The average masking noise level will seem to increase by a factor of $10 \log 27 = 10 \log 128 = 21 \text{ dB}$ when zooming out from minimum to maximum span, and this may well hide some tones. The tone assessment standard set requirements for the span so as to prevent this from happening.

Fig. 12

Left: Zooming out makes a tone less visible
Right: Same tone made visible by zooming in

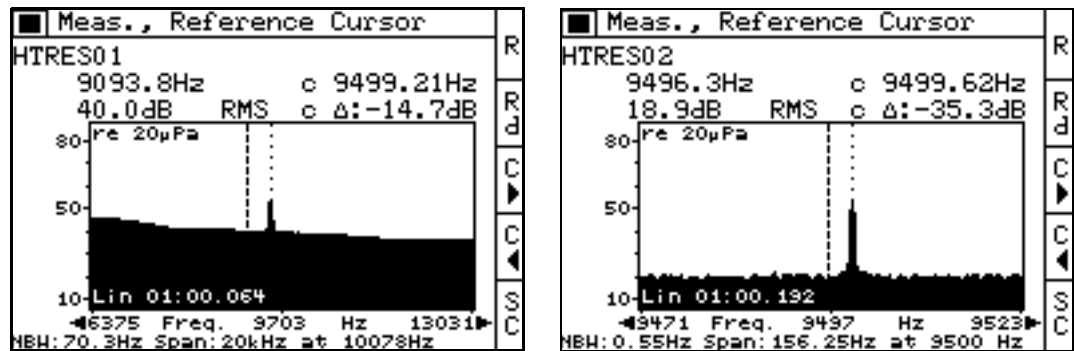

Masking

Masking noise is the sound which does not belong to the tone, and which limits (masks) the audibility of the tone. In the spectrum, only sound within a certain frequency range around the tone affects the audibility. This range is called the critical band.

The masking noise level is calculated using linear regression. In the automatic tone assessment described in the standard (and used in Type 2260 H), a first-order linear regression is made, based on all noise lines in the range ± 0.75 to ± 2 critical bands. Of course, the regression line can be at an angle to the frequency axis. Then the level indicated by the regression line is assigned to each line in the spectrum within the critical band, and the average of those line levels is calculated on an energy basis.

Masking Noise Level

The total sound pressure level of the masking noise L_{pn} is determined from the average noise level within the critical band. In the average, all maxima resulting from tones and

their possible sidebands are disregarded. L_{pn} is calculated from the average by adding $10 \log$ (Critical Bandwidth/Noise Bandwidth). This procedure is equivalent to energy summing the levels of the interpolated noise lines.

As an example, if the tone is at 1000 Hz the critical bandwidth is 20% of 1000 Hz = 200 Hz. The Noise Bandwidth should be at least 5% of 200 Hz, i.e., 10 Hz, so it could be set to 5.86 Hz (the span is then 2.5 kHz in Type 2260 H). L_{pn} is then the average noise level in the 200 Hz band around 1 kHz, plus $10 \log (200/5.86) = 15.3 \text{ dB}$.

In the 2260 H display, the masking noise level L_{pn} is shown by the position of a horizontal bar, its width and position indicating the critical band (see Fig. 11). The bar will be positioned above the FFT spectrum of the masking noise, and the relative position of the bar depends on the frequency resolution, since the noise energy within the critical band is spread over the number of lines available.

Critical Band

The critical band (the frequency range that can mask the tone) is centred on the tone, and its width is 100 Hz below 500 Hz, and 20% of the tone frequency above 500 Hz. Note that above 500 Hz this is close to the bandwidth of 1/3-octave filters (23%), while it is progressively wider at lower frequencies.

If more than one tone is found within a critical band, the critical band is placed symmetrically around the tones in the critical band, centring on the sum of frequencies divided by the number of tones. Only tones with levels within 10 dB of the highest tone level are included in the positioning of the critical band. If not all tones can be included in the critical band, that placement of the critical band is selected which yields the highest difference between tone level and masking noise level.

Measurements

Setup

The setup of Type 2260 H should be made so the results fulfil the requirements of the standard. The important parameters and recommended settings are shown in Table 2.

Table 2

Parameter	Recommended Setup	Comment
Input Type	Sound	Note 1
Time Averaging	Linear	Note 2
Averaging Time	1 minute	Note 3
Frequency Span	NBW* less than 1% of tone frequency. Distance from tone frequency to border: below 500 Hz: at least 50 Hz away; above 500 Hz: at least 10% of tone frq.	See Default Setups on page 14
Centre frequency	To suit the span	
Standard	JNM2, ISO or DIN, to comply with regulations	Can be changed after measurement
Tone-peek Criterion	1.0 dB	

Note 1: If Input Type is not Sound (i.e., Vibration or Direct), tones are indicated but no other results are shown

Note 2: Exponential Averaging is useful while searching for the right measurement conditions

Note 3: Set the Avg. Spectra to get the Averaging Time close to (but not below) 1 minute

Note 4: NBW is the noise bandwidth, also known as the effective analysis bandwidth. The noise bandwidth is the bandwidth of an ideal filter (box-shape frequency response) that passes the same noise energy as the actual filter. For the FFT used for tone assessment (using Hanning time window), the NBW is equal to the line spacing multiplied by 1.5. In the standard, the required bandwidth is specified in terms of effective analysis bandwidth

Even if all the requirements of the standard are not met, the tone assessment can still be made, and status codes are then shown with the results to indicate the deviations. The status codes (shown in Table 4) can also warn if the algorithm encountered any problems when assessing the spectrum. On-line Help is available to suggest ways to improve the setup (please refer to Results on page 18).

Measurement Span

As a rule of thumb, set the NBW (see Note 4 above; NBW is shown in the lower left-hand corner of the screen) to less than 1% of the centre frequency of the suspected tone.

The NBW should be less than 5% of the width of the lowest critical band with tonal components. Since the critical band is 20% of the centre frequency above 500 Hz, and 5% of 20% is 1%, the rule of thumb will work in practice. Below 500 Hz, it is stricter than needed.

You can also use “trial and error” – the display will show the “z” code if you need to zoom in, and the “!” code if the tone is too close to the border of the span.

Default Setups

For tone assessment, you want as wide a span as possible to catch all possible tones. On the other hand, the standards for tone evaluation set requirements to the maximum FFT resolution around the tone frequency. To fulfil these conflicting requirements, the following settings can be used to cover the main part of the audio spectrum. An overlap of about 2 critical bands is provided between the setups, to allow for tones at the border of spans.

Fig. 13
Default spans

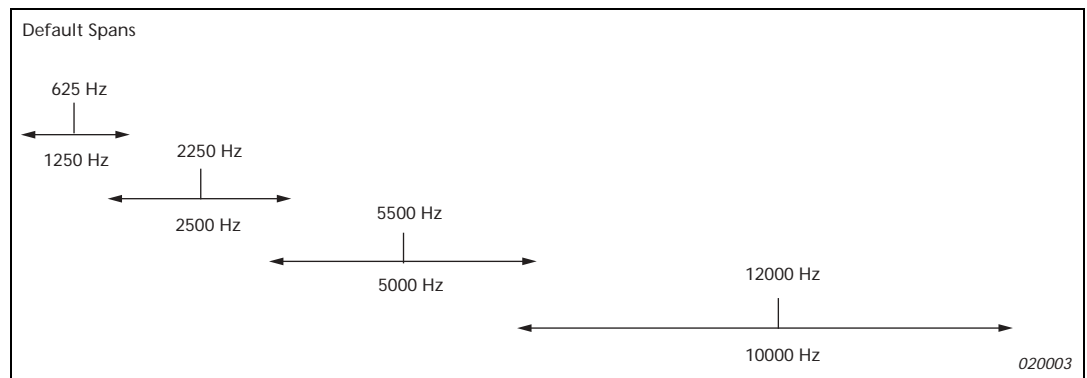

Table 3
Default Type
2260H Setups.
Only the three pa-
rameters in bold
need to be set up.
The others are set
by Type 2260H

Parameter	Setup 1	Setup 2	Setup 3	Setup 4
Avg. Spectra	600	1200	2400	4800
Frq. Span (Hz)	1250	2500	5000	10000
Gen. Frq. (Hz)	629	2250	5502	12006
Span Start (Hz)	0.01	1000	2990	6990
Span End (Hz)	1260	3500	8010	17000
Critical Band at Span Start (Hz)	100	200	600	1400
Effective Bandwidth (NBW) (Hz)	4.39	8.79	17.6	35.2
Required NBW Hz (5% of Critical Band)	5	10	30	70

Aural Monitoring

The Aux.2 socket at the base of Type 2260 H can be configured to act as a signal output. You have a choice of three signals – Input, Tone, or both. The gain is separately adjustable for Input and Tone.

The Input setting alone is typically used for sound recording on DAT or a PC. (Remember to set the Pre-weighting in the Input Set-up to None if you don't want the recorded signal to be A-weighted. You can then apply post-weighting to get your spectrum A-weighted.) For this application, the Gain Tone is typically set close to 0 dB to get the optimum signal to noise ratio for the recording.

The Input + Tone setting is useful to subjectively confirm the tone assessment. The input signal is mixed with the output of a tone generator inside Type 2260 H. You set the tone frequency using the cursor in the display, and the tone gain should be set to make the tone just audible above the input signal, in order not to mask the suspected tone at the input. You connect your headphones to the Aux.2 output using Headphone Adaptor AO 0522. In the Meas., Tone menu, an On/Off softkey is provided to make it easy to compare the generated tone to the suspected tone in the input signal.

Fig. 14
 Left: Aux.2 set up to output the microphone signal mixed with a tone at the cursor frequency
 Right: You can turn the tone output on and off using the Tone Out softkey

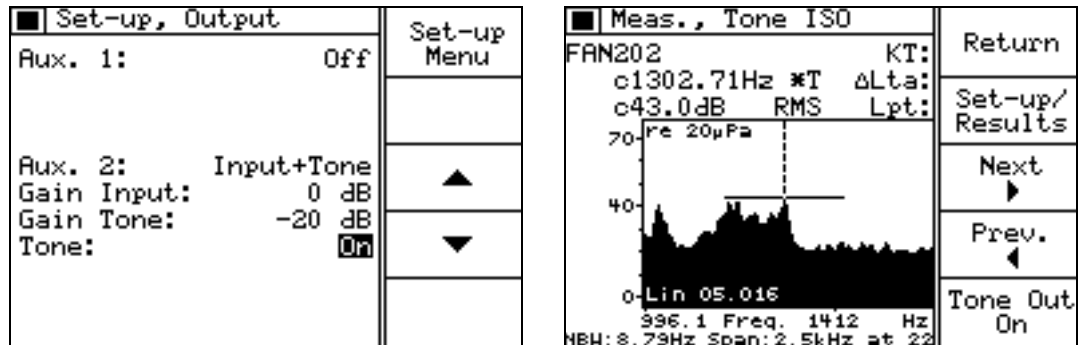

Sound Recording

Please refer to Appendix: Sound Recording on page 29.

Calculations

Tone assessment in Type 2260 H follows the rules given in the standards. The calculations described below are those following the JNM2 method.

First, the calculation algorithm looks for Noise Pauses in the spectrum. A Noise Pause is a local maximum in the spectrum with a probability of containing a tone. FFT lines identified as Noise Pauses are marked with a “P” in the display when selected by the cursor.

The tone-peek algorithm then looks for tones inside the noise pauses by finding maxima with a level 6 dB or more above the neighbouring line. The line with the highest level is used to define the critical band and check the 3 dB bandwidth criterion. If this criterion is not fulfilled (i.e., the “tone” bandwidth exceeds 10% of the width of the critical band), the lines are regarded as neither tones nor narrow band noise.

When the tone candidate fulfils the 3 dB bandwidth criterion, all lines with levels within 6 dB of the maximum level are identified as belonging to the tone. The algorithm re-classifies those lines qualifying as tones and marks them with a “T” in the display, shown when the cursor is on the line.

The Tone-Seek Criterion in the Tone Assessment – Setup/Results menu is the threshold for the algorithm that looks for a Noise Pause in the spectrum, i.e., differences between successive line levels. The tone seek criterion is used with all the three standards in Type 2260 H when classifying the spectrum. The criterion may be interpreted as the normal step in level between neighbouring lines in “flat” parts of the spectrum. In general this criterion should be set to 1 dB. For irregular spectra (mainly spectra with short averaging time) values up to 4 dB may give better results. Increasing the averaging time (if possible) may help as well.

Fig. 15

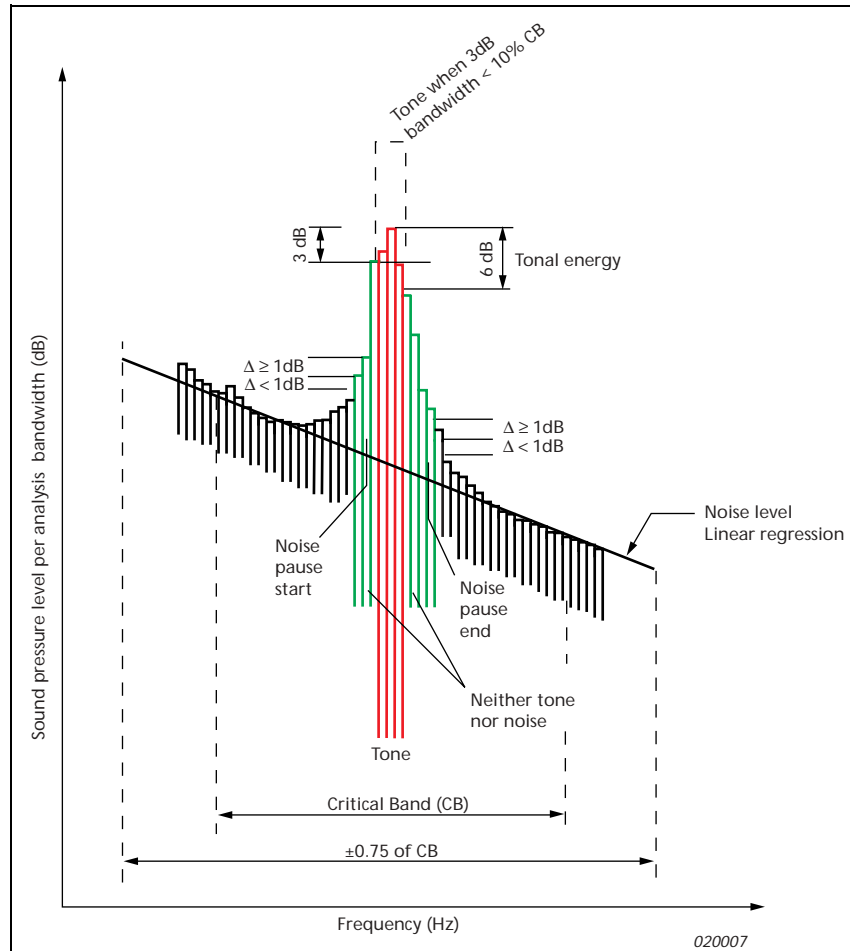

Adding up the Lines of Tones

Usually, the frequency of a tone does not coincide precisely with one line in the FFT spectrum. Instead, its energy is spread over several lines. From the level of the two most prominent lines, a good estimate of the true tone frequency (Corrected Frequency) and level is calculated.

Corrected Frequency is used, if possible, on the lines classified as “T” (tone lines). In the case of a single line, its level is used with no correction. If more than 2 lines are present, the energy sum is corrected by $-1.76 (\log 1.5 = \log \Delta f/\text{NBW})$.

Within one critical band, several tones may be found. The resulting level for every tone (see above) is added on an energy basis.

The tone assessment evaluates all the tones found and the possible associated critical bands. The critical band – the decisive critical band – that yields the highest audibility is reported as the final result. The most prominent tone is the tone with the highest audibility within the decisive critical band.

The results for tones in other bands are also shown. In some special spectra you might find a tone with higher audibility than that of the decisive critical band – this is because the tone level is very low; a tone can be disregarded if its level is more than 10 dB below the tone with the highest level in the critical band.

Audibility

The audibility ΔL_{ta} is calculated from the difference between tone level L_{pt} and masking noise level L_{pn} .

The equation (by Zwicker) used to calculate the audibility is:

$$\Delta L_{ta} = L_{pt} - L_{pn} + 2 + \log \left[1 + \left(\frac{f_c}{502} \right)^{2.5} \right]$$

Consequently, for low frequencies (below about 500 Hz), the audibility is

$$\Delta L_{ta} = L_{pt} - L_{pn} + 2.$$

For tone frequencies above 500 Hz, the audibility increases with frequency; at 8 kHz the audibility is 3 dB higher than at low frequencies (in otherwise similar conditions).

The last part of the equation is shown graphically in Fig. 18.

Penalty

The penalty k is calculated from the audibility.

- If the audibility is less than 4 dB, no penalty is incurred
- If the audibility is over 10 dB, the penalty is 6 dB
- Between 4 and 10 dB, the penalty is $\Delta L_{ta} - 4$ dB

Note that the penalty is not restricted to integer values.

Example 1

Tone level	= 61 dB at 125 Hz (well below 500 Hz)
NBW	= 5% of 100 Hz = 5 Hz
Critical band	= 100 Hz centred at 125 Hz
Average noise level	= 50 dB
Masking noise level	= $50 + 10 \log 100/5 = 63$ dB
Audibility	= $61 - 63 + 2 = 0$ dB, meaning the tone is just audible.

Example 2

Tone level	= 61 dB at 8 kHz
NBW	= 5% of 1600 Hz = 80 Hz
Critical band	= 20% of 8 kHz = 1600 Hz
Average noise level	= 50 dB
Masking noise level	= $50 + 10 \log 1600/80 = 63$ dB
Audibility	= $61 - 63 + 2 + 3 = 3$ dB, meaning the tone is audible, but no penalty is incurred

Results

When entering the Tone Assessment screen (press the “Tools”, “Tone Assessment” softkeys), or when recording or loading a spectrum to this screen, the pure tone analysis is automatically performed. The text “Calculating” will be displayed while the analysis takes place. During the calculation, the user can exit the tone assessment screen and come back at a later stage to inspect the results. Once the analysis is done the cursor will be positioned at the most prominent tone and the results will be displayed on the <Tone Assessment> and the <Set-up/Results> screen. Fig. 16 shows the results of a pure tone assessment.

Fig. 16
Results of pure
tone assessment

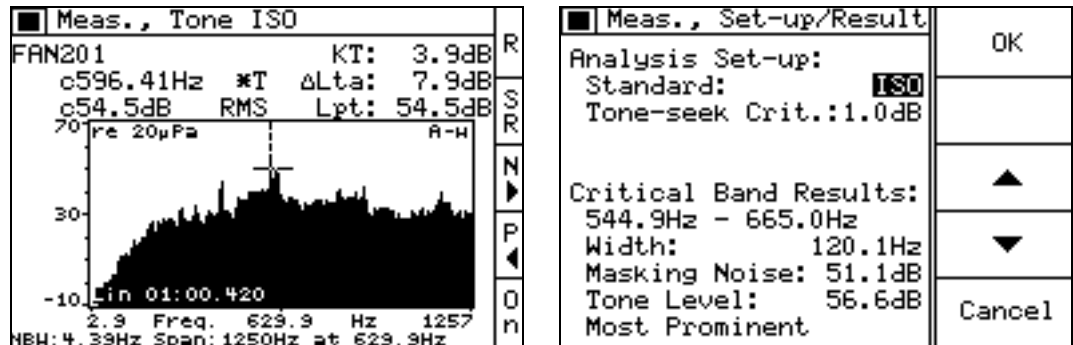

Graphically, the result is indicated in the following way:

- The main cursor is placed at the most prominent tone in the decisive critical band
- The decisive critical band is indicated by a horizontal bar
- The vertical position of the bar indicates the level of the masking noise in the critical band

You can use the Next > and Prev < softkeys to move the main cursor to review other tones and other critical bands. You can return to the original cursor placement either by using the Next > and Prev < softkeys, by pressing the “Most Promin.” softkey, or by repeating the tone assessment.

The results are displayed in a number of different ways as explained below.

Result Parameters

In the display, the result is shown using the following symbols:

- K Penalty as a result of the tone assessment for the spectrum
- L_{pt} Level of each tone found in the tone assessment
- ΔL_{ta} Audibility for the tones in the critical band

The scope of each is shown in the following table:

Symbol	Parameter	Scope
K	Penalty	Spectrum
ΔL_{ta}	Audibility	Critical band
L_{pt}	Tone level	Individual tone

The symbols used are slightly different for the ISO and DIN standards – please refer to Standards on page 23 to see the differences.

Classification codes

In the display, a code is shown for each line when selected by the cursor. This code indicates the classification made by the tone-peek procedure:

- T: **Tone** Used to calculate the tone level L_{pt}
- *T: **Tone** Most prominent tone in decisive critical band
- N: **Masking Noise** Used to calculate the masking noise level L_{pn}
- P: **Neither tone nor masking (Noise Pause)** Not used for further calculations

By moving the main cursor around, the classification of the entire spectrum can be investigated. This is, for example, useful when investigating which lines in the spectrum have contributed to the tone and mask levels.

When the cursor is positioned at the max level of a different tone (either by using the main cursor or the ◀ ▶ soft keys) the tone level will change. When it is positioned at a tone belonging to another critical band the audibility will change. The penalty will remain constant regardless of the cursor position, since it is valid for the entire spectrum.

Critical band details

On the <Set-up/Results> screen some details are shown concerning the critical band at the cursor position. Observe that these details are only shown when the cursor is placed at the max level of a tone (use the ◀ ▶ soft keys to browse between these). It is possible to see the start and end frequency of the band, the level of the masking noise, and the total tone level within the band. The tone level shown here is the one that the calculation of audibility and penalty is based upon.

Most prominent tone

Right after the analysis is performed, the cursor will be positioned at the most prominent tone. This is the tone with the highest level placed inside the critical band chosen by the standard to lead to the calculated penalty. With the cursor at this position, the data shown on the two screens is the data that should be reported to document the analysis. Be aware that when the cursor is positioned at different tones, the data on the screens is not the data that yields the calculated penalty. To avoid mistakes, the most prominent tone is marked with a "*" in the classification. Always ensure that the cursor is positioned correctly before documenting the result.

The L_{pt} (tone level) may be different from the main cursor read-out unless the Corrected Frequency option is turned on. For example, the tone assessment might show a tone at (main cursor) 157.7 Hz at a level of 74.0 dB. The tone assessment shows the L_{pt} (tone level) as 74.5 dB. Turning the Corrected Freq. to On, the main cursor now shows c157.83 Hz and c74.5 dB; the "c" indicates corrected frequency. (Note: for tones with more than 2 lines, the L_{pt} can deviate from the "c" level).

For the main cursor, Corrected Frequency can be selected "On" in the "Edit Display" soft key menu. When the main cursor is then placed on a tone, the corrected frequency and level will be shown in the main cursor read-out.

Improving Results

The analysis can be performed on any measured sound spectrum, even if the requirements and recommendations of the standards are not fulfilled. In the latter case, the analysis will be performed anyway and status codes will be displayed to show which requirements are not met. The status codes can also warn if the algorithm encountered any problems when assessing the spectrum.

The status codes are listed below, and possible improvements are suggested.

Table 4
Tone Assessment
Codes

Code	Help message	Requirements	
		JNM and ISO	DIN
z	Zoom-in needed	NBW ≤ 5% of critical bandwidth	NBW ≤ 12% of critical bandwidth
t	Avg. Time too short	≥ 1 minute	≥ 30 spectra
L	Linear Averaging required	Lin	Lin
!	Tone too close to border		
h	Hanning window needed	Hanning	Hanning
f	Frequency Weighting wrong	A	None*
p	Twin Peaks detected		Not applicable
N	Tone exceeds critical band		

* No code is set – please refer to notes below

Type 2260H shows the status code next to the spectrum, as shown in Table 4 along with the corresponding requirements in the standards. The Help message is shown when you press the Help (?) hardkey.

Notes:

z – Zoom-in needed

Zoom-in requirement is in % of lowest critical band with tones. As a rule of thumb, set it to 1% of the tone frequency

t – Averaging time too short

A sufficiently long averaging time will smooth the masking noise spectrum and therefore helps separate the tones from the masking noise

For DIN, at least 30 spectra are normally used, but in case of doubt about tonal content, up to 100 spectra may be needed

However, if the tone varies over the averaging time, its FFT spectrum will get smeared. If the tone varies by more than 10% of the critical bandwidth, the tone-seek algorithm will not find the proper results. The averaging time can then be subdivided and the tone level found as the energy average of the tone levels found in the short-term spectra

L – Linear averaging required

Linear averaging gives equal weight to all records included in the averaging time. Exponential averaging is useful when searching for the proper measurement conditions, but is not suitable for accurate tone and masking noise measurement

! – Too close to border

The search algorithm, after finding a tone candidate, sets up the Critical Band around it. This limits the maximum range (JNM) to 50 Hz – 18.2 kHz for tones, if the critical band must not exceed the span. However, in Type 2260 we allow tones to be detected in the full span (if the resolution is sufficient). But if the critical band cannot fit within the span, the ! code is shown

The search algorithm starts looking for the noise level within $\pm 0.75 * CB$ (Critical Bandwidth), and if the noise level cannot be identified, extends the search to $\pm 2 * CB$. In Type 2260, if the span does not allow this extended search, this is not

taken as a fault by itself. This means that tones can be found below 50 Hz and above 18.2 kHz

h – Hanning window needed

If the measurement setup is chosen correctly (Meas. Start = Manual, or if Meas. Start = Triggered, and Signal Type = Continuous), the Window will automatically be set to Hanning

f – Frequency weighting wrong

If the standard requires the frequency weighting “None” (as DIN does), and the measurement was made using A-weighting, Type 2260 H will automatically apply inverse A-weighting for the calculations as allowed by the standard, and no warning code will appear

For the JNM and the ISO standards, which require A-weighting, a warning code appears if the measured data is not correctly weighted, and the user can take suitable action (such as turning the “Post-weight” on in the “Edit Display” menu)

p – Twin peaks detected

If more than one peak was found at a tone, the “p” code is shown. It can be caused by a complex tone with many closely spaced tone components, or a tone with varying frequency. A finer resolution than the standard 5% of critical band may be needed to determine the level of the masking noise correctly. Zooming in and/or decreasing the tone-peek criterion may be helpful

N – Tone exceeds Critical Band

This code is shown if too many tone candidates (lines with a “P” code) are found in succession, with no “N” (masking noise) lines in between. Then the algorithm cannot recognize the tone since no masking noise level can be found.

This can happen if the tone is very prominent, such as the tone from a calibrator or the tone from a piano (low background noise). The frequency spectrum for this kind of tone looks like a narrow bell, with no “flat” sections to allow determination of the masking noise level. No masking noise lines are found within the critical band, so the tone assessment cannot proceed. This condition is indicated by an “N” code in the display, and the cure is to change the tone-peek criterion (it can be increased from the default 1 dB up to 4.0 dB and down to 0.5 dB).

Another case that may cause the N code to appear is a spectrum having very smooth and gradual slopes (such as seen in electronically generated noise). Using the default tone-peek criterion, the majority of lines are classified as “P” (Noise Pauses i.e. tone candidates), but no tone is actually found within the width of a critical band, and no “N” lines (noise lines). The cure might be to decrease the tone-peek criterion to 0.5 dB.

Note that in Type 2260 H, you cannot know which part of the spectrum caused the “N” code to appear.

Setup requirements

- The standards prescribe RMS scaling. If a different scaling is set by the user, this is compensated for by the software
- If the Input Type is not Sound (as an example, it could be set to Acceleration), the calculation will be performed, but no result parameters will be shown, and the message “NOT SOUND” will be shown in the display. The “Next” and “Previous” softkeys can be used to toggle between the significant “tones”, and this can be useful to identify peaks
- Sound Incidence must be properly set for the type of acoustical environment

Report

According to the JNM2 standard, the following data must be reported:

For the analysis

- Number of averaged spectra and averaging time
- Time window (Hanning), time weighting (Lin.), and frequency weighting (A)
- Effective analysis bandwidth (= NBW)
- One typical spectrum (at least)

For the calculations in the decisive critical band

- A statement telling whether the results were obtained by visual inspection or by automatic calculation
- The frequency limits of the critical band with the most prominent tones (decisive band)
- The frequencies and levels of the tones in that band (L_{pt} in dB re 20 μ Pa)
- The masking noise level in the critical band (L_{pn} in dB re 20 μ Pa)
- The audibility of the tones (ΔL_{ta} in dB above the masking threshold)
- The size of the penalty (k in dB)
- It is recommended that the spectrum is shown together with an indication of the position of the critical band and of the average noise level in that band
- Tones in other critical bands that may cause a penalty should be mentioned by their frequencies.

All the data needed for the report can be found in Type 2260 H.

Fig. 17

For the analysis

Number of averaged spectra →

■ Set-up, Meas. Ctrl.		Set-up Menu
Meas. Start:	Manual	
Averaging:	Linear	
Avg. spectra:	2106	
Avg. Time:	01:00	
Logging:	Off	▲
		▼

For the analysis

Hanning time window →

■ Set-up, Zoom Func.		Set-up Menu
Freq. Span:	5kHz	
Cen. Freq.:	2519.531Hz	
Rec. Length:	85.33ms	▲
Freq. Res.:	11.719Hz	▼
Noise BW:	17.579Hz	
Window:	Hanning	
Overlap:	67%	

Fig. 17 (cont.)

For the decisive critical band

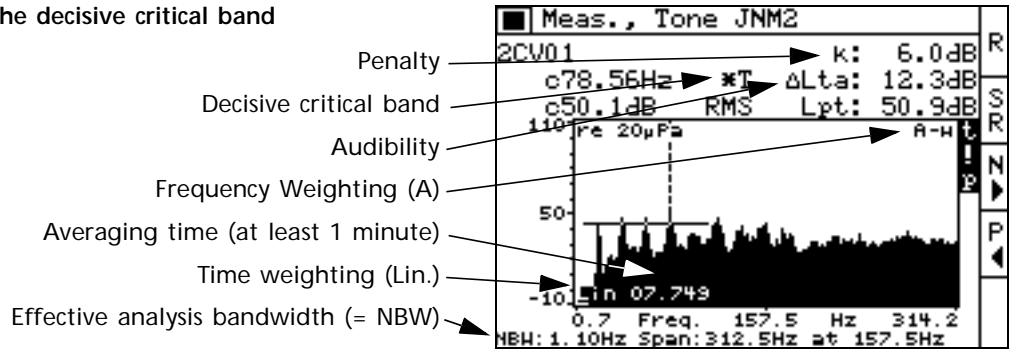

For the decisive critical band

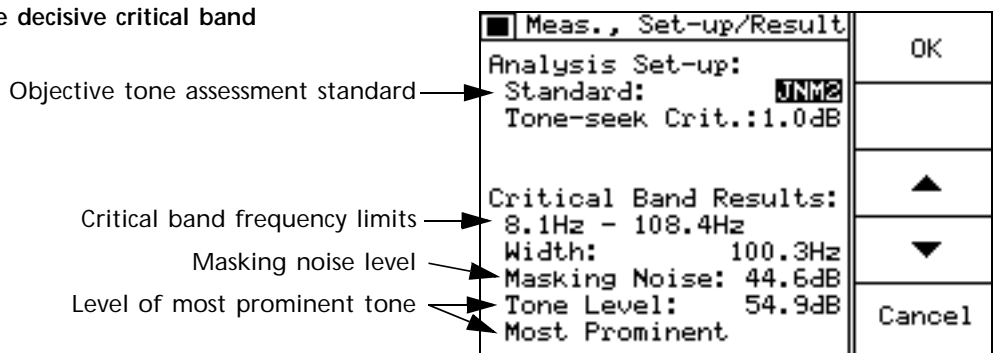

For the decisive critical band

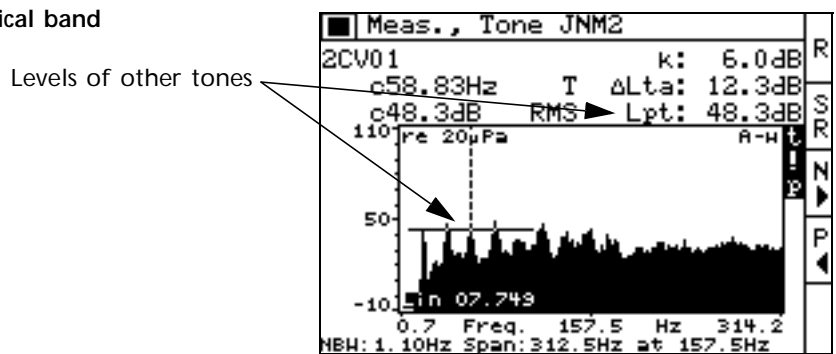

Standards

Currently, three standards are supported in Type 2260 H:

- JNM2: “Joint Nordic Method - Version 2”, 1999
- DIN: “DIN 45681”, 1992
- ISO: “ISO/CD 1996-2”, May 2001

These standards are all living documents and are being continuously refined. They differ both in their definition of tones, their calculation of tonal and masking levels and their resulting penalty. A detailed discussion of the three standards is outside the scope of this text. However, a few comments could help explaining the similarities and differences in the behaviour of the methods:

- The ISO method greatly resembles the JNM2 and will in most cases yield exactly the same results. The ISO differs only slightly in the classification of the spectrum and will in some cases yield lower audibilities than JNM2. As of September 2001, the only difference between JNM2 and ISO is the omission in ISO 1996 of procedure no. 2 in the JNM2 tone seek procedure. ISO is expected in the future to agree 100% with JNM2 (by referring directly to it)

- In contrast to the other methods, the DIN method ignores all tones in the critical band more than 10 Hz away from the prominent tone. This means the DIN method will yield lower audibilities in many multiple-tone scenarios
- In the DIN method, the tone lines are added on an energy basis. In the JNM2 and ISO, the tone level is the “Corrected Frequency” level, which takes into account the Hanning window
- The audibility in the DIN standard is (using JNM2 terms):
 $\Delta L_{ta} = L_{pt} - L_{pn} + 6$ in contrast to the JNM2/ISO scheme:
 $\Delta L_{ta} = L_{pt} - L_{pn} + 2 + \log \left[1 + \left(\frac{f_c}{502} \right)^{2,5} \right]$ (please see graph below)
- The penalty vs. audibility relation is a step curve for DIN while it is a continuous curve for the JNM2/ISO. Also, the starting point and slope is different, compensating to a some degree for the difference in audibility calculation
- DIN also differs in the requirements for noise bandwidth, frequency weighting, duration of averaging and definition of critical bandwidth. These differences will not normally affect results significantly. The differences are summarized in Table 5

Table 5
Standards for FFT
Tone Evaluation

	DIN 45681 1992 Draft	JNM2 1999 and ISO 1996–2 May 2001
Penalty	K_T	k (k_T for ISO)
Audibility	ΔL	ΔL_{ta}
Tone level	L_T	L_{pt}
Effective Analysis bandwidth NBW	$\leq 12\%$ of critical band	$< 5\%$ of critical band
Frequency Weighting	None	'A'
Duration of averaging	30 – 100 records	≥ 1 minute
No. of 'noise' lines	≥ 10	
Lowest tone freq. (Hz)	100 ¹	
Lowest critical band		0 – 100 Hz
Critical bandwidth at centre frequency f_c	Zwicker equation ²	50– 500 Hz: 100 Hz >500 Hz: 20% of f_c
Correction of masking noise level		Correct for Hanning window ³
Correction of tone level	Add tone line levels	“Corrected Frequency” level ⁴
Several tones in one critical band	Use most prominent ⁵	Add tone levels
Audibility criterion	$L_t > L_n - 6\text{dB}$	Zwicker
Fluctuating tones	Limited application ¹	Frequency variation $> 10\%$ of critical band: special calculation
Penalty function	1 dB Steps	Continuous
User defined parameters		Tone seek criterion 1 – 4 dB

¹ Below 100 Hz or with fluctuating tones, objective method cannot replace subjective evaluation

² The Zwicker equation for critical bands is: $\Delta f = 25 + 75 \times \left[1 + 1,4 \times \left(\frac{f_c}{1000} \right)^{2,0,69} \right]$

³ The Hanning window correction is $10 \log \frac{\text{LineSpacing}}{\text{NoiseBandwidth}} = 10 \log \frac{1}{1,5} = -1,76\text{dB} \approx -1,8\text{dB}$

⁴ If a tone is found containing lines not suitable for the Corrected Frequency algorithm (which could happen with time-varying or other special signals), Hanning Window correction is applied (0 dB for a single line and -1.8 dB for three or more lines)

⁵ But if close together (within 10 Hz or less), add tone levels

Fig. 18

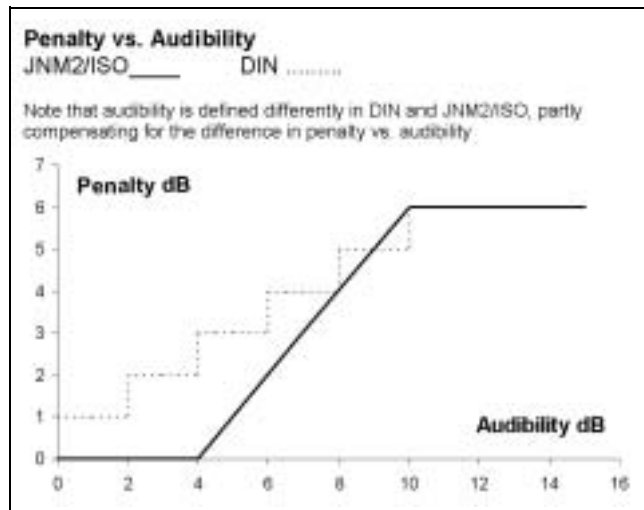

Fig. 19

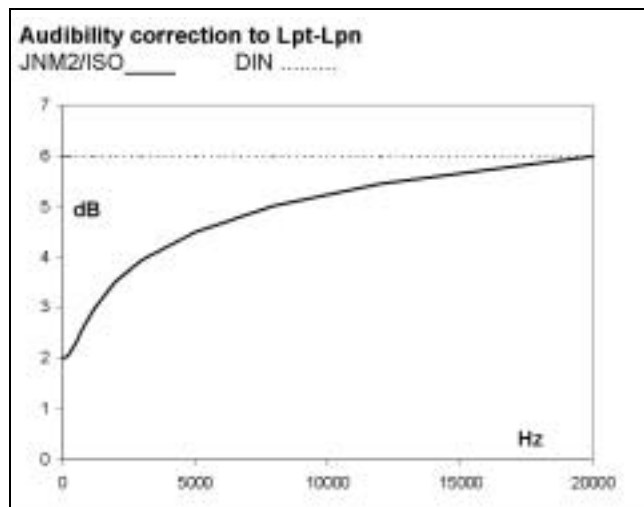
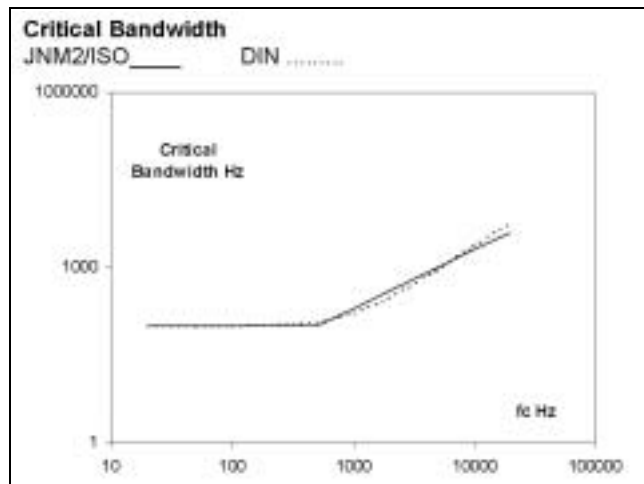

Fig. 20



Examples

To illustrate the use of tone assessment in Type 2260 H, and the differences between standards, the analysis of a synthetic signal is shown. The signal contains broadband noise with tonal components at 1 kHz, 2 kHz, 2.4 kHz and 9.5 kHz. The results for the JNM2 standard are compared to those for the DIN standard.

Broadband Overview

A broadband measurement is made and used as the basis for tone assessment for both standards. In the example, the measurement file is TONES01.

Fig. 21 Top: JNM2 – 2 kHz, 2.4 kHz, 9.5 kHz tones. Bottom: DIN – 2 kHz, 2.4 kHz, 9.5 kHz tones

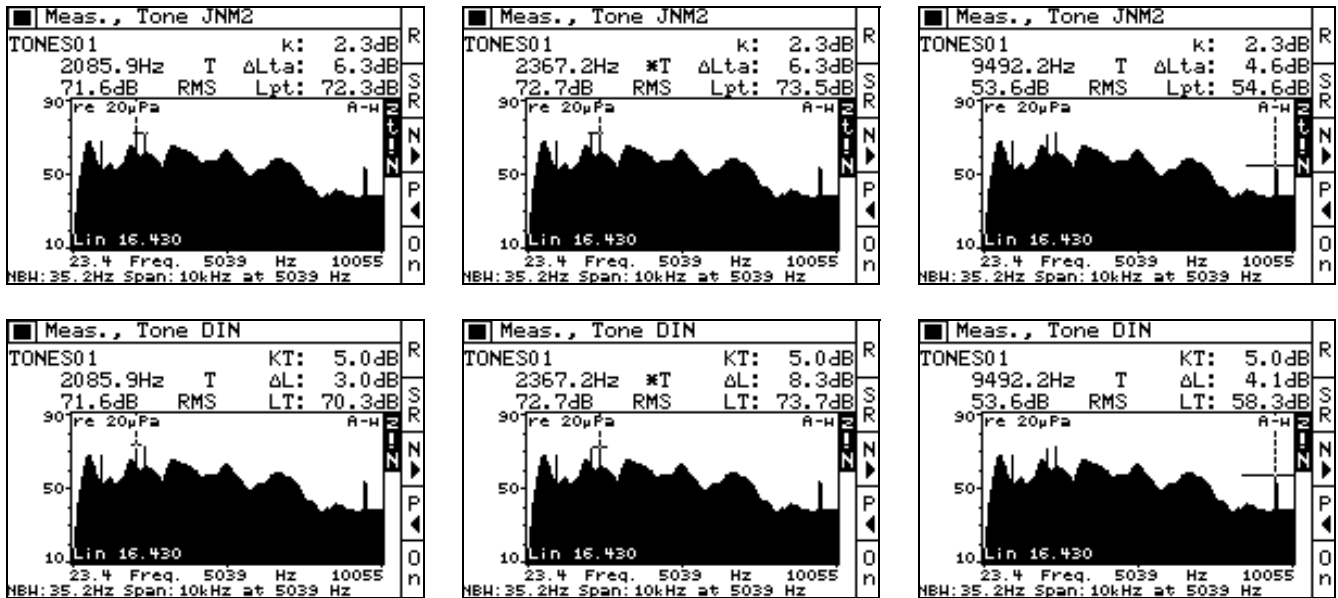

Referring to Fig. 21, both methods find tones at 2 kHz, 2.4 kHz and 9.5 kHz, but find different audibilities and penalties (the JNM standard denotes audibility by ΔL_{ta} and DIN by ΔL). Observe that the JNM method has combined the tones at 2 kHz and 2.4 kHz into one critical band while the DIN method treats these tones separately. The dominant tone is found at 2.4 kHz for both standards (the dominant tone is marked by the '*' on the classification letter, "T").

Although the analysis found tones, a number of status codes suggest that some caution must be observed before using the results:

- z: Indicates that the resolution of the measurement is too poor to correctly assess tones at lower frequencies (NBW is 35.2 Hz while NBW < 5 Hz is required for JNM and NBW < 12 Hz is required for DIN)
- t: The averaging time of 16 seconds was too short for JNM (1 minute required)
- !: The tone at 9.5 kHz is too close to the upper frequency limit at 10 kHz (the tone needs to be half a critical band away from the upper frequency, i.e., ~1 kHz)
- N: A tone candidate is wider than the corresponding critical band (this status code shall be ignored here as it is caused by the very smooth artificial spectrum which actually requires a smaller tone seek criterion than the default value of 1.0 dB used for natural audio measurements)

To eliminate some of the status codes the span is moved a little towards higher frequencies and the averaging time is increased. The measurement file is now TONES02.

Adjusting Span and Averaging Time

Fig. 22 Top: JNM2 – 2 kHz, 2.4 kHz, 9.5 kHz tones. Bottom: DIN – 2 kHz, 2.4 kHz, 9.5 kHz tones

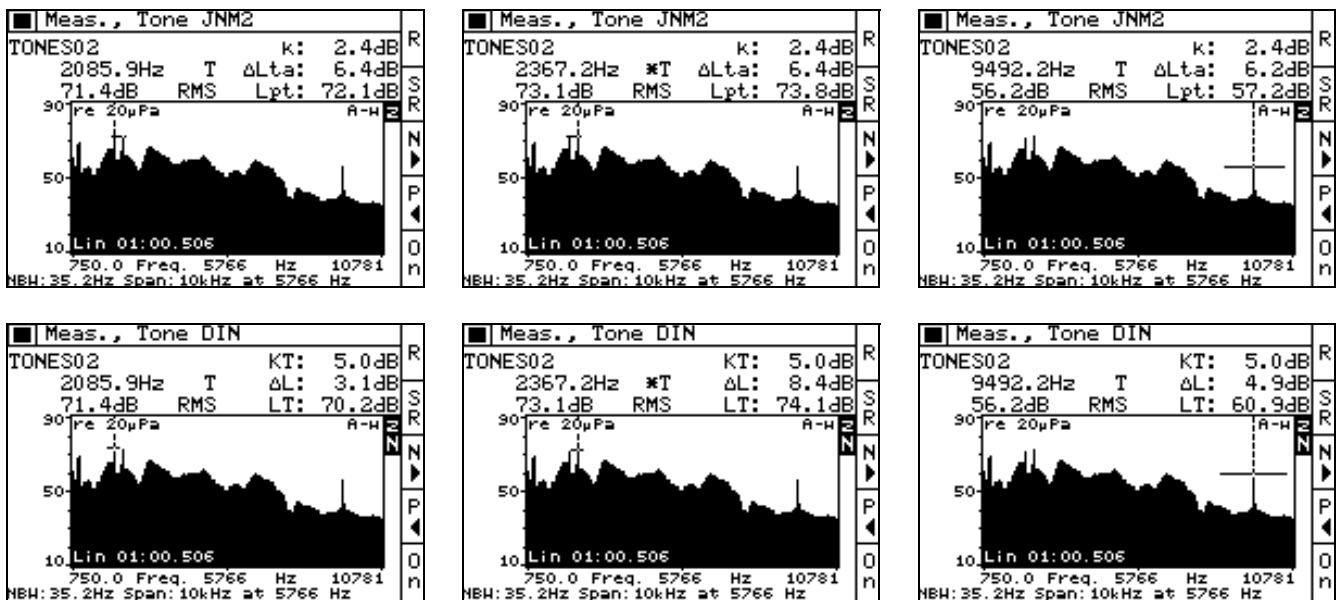

The dominant tone is still found at 2.4 kHz for both methods (Fig. 22). The tone at 9.5 kHz is now analysed correctly but is less audible than the other tones and can therefore be excluded from further analysis.

Since the z code still appears, the results at low frequencies cannot entirely be trusted. The spectrum is therefore analysed in greater detail at lower frequencies. The measurement file is TONES03, see Fig. 23.

Zooming in

Fig. 23 Top: JNM2 – 1 kHz, 2 kHz, 2.4 kHz tones. Bottom: DIN – 1 kHz, 2 kHz, 9.5 kHz tones

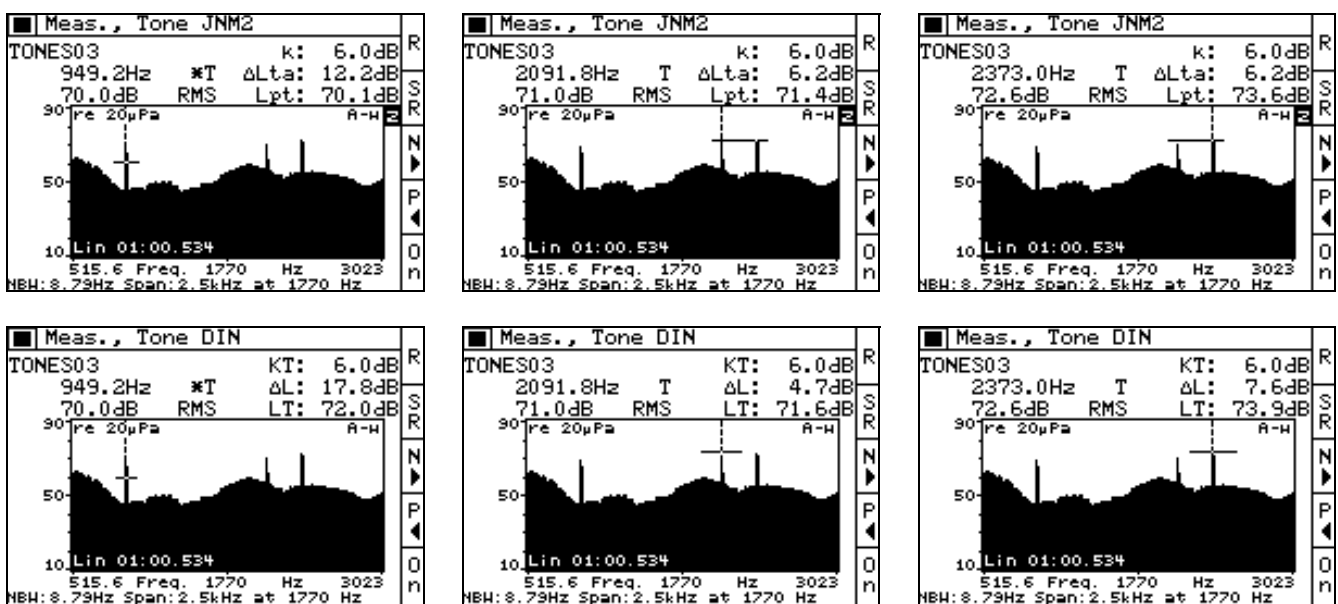

Now the tone at 1 kHz is also detected and proves to have higher audibility than the remaining tones. The DIN method is now satisfied and the result of the tone assessment can be read from the top right-hand corner of the screen and by entering the <Set-up/Results> screen while positioned at the dominant tone (press soft key 2). To increase the accuracy further, and thereby satisfy the JNM standard requirements and improve the accuracy of the DIN standard, the span of the spectrum can be further reduced. Measurement file TONES04 is used, see Fig. 24.

Final results

Fig. 24
Result spectra
Left: JNM2
Right: DIN

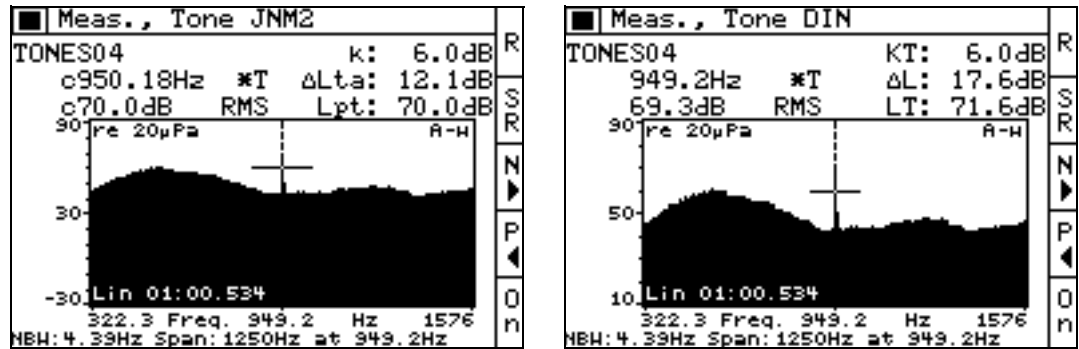

Both standards are now completely met and the resulting penalty can be read from the top right corner. Details concerning the critical band can be found in the <Set-up/Results> screen:

Fig. 25
Critical band results
Left: JNM2
Right: DIN

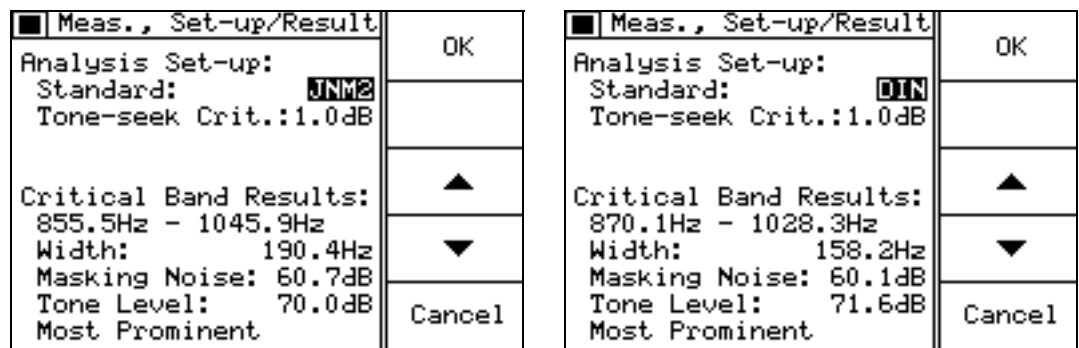

The two methods yield quite similar results here. However, some interesting observations can be made:

- The JNM standard finds the tone level 1.6 dB lower than DIN. This is because the JNM method corrects for Hanning effects (the JNM tone level is identical to the corrected frequency value displayed in the top left corner)
- The width of the critical band differs for the two standards as the JNM standard uses only an approximated Zwicker equation (critical band width ~20% of tone frequency)
- The audibility criterion of the two methods differ significantly (although the methods find similar tone and mask levels, the audibilities are quite different)

Appendix: Sound Recording

Sound Recording on a PC

If you have one of the following programs installed on your PC, you have a convenient way to record sound: 7815 Noise Explorer, 7820 Evaluator or 7825 Protector.

Please follow the procedure below, and refer to the PC software Help on Sound Recorder for details.

Fig. 26

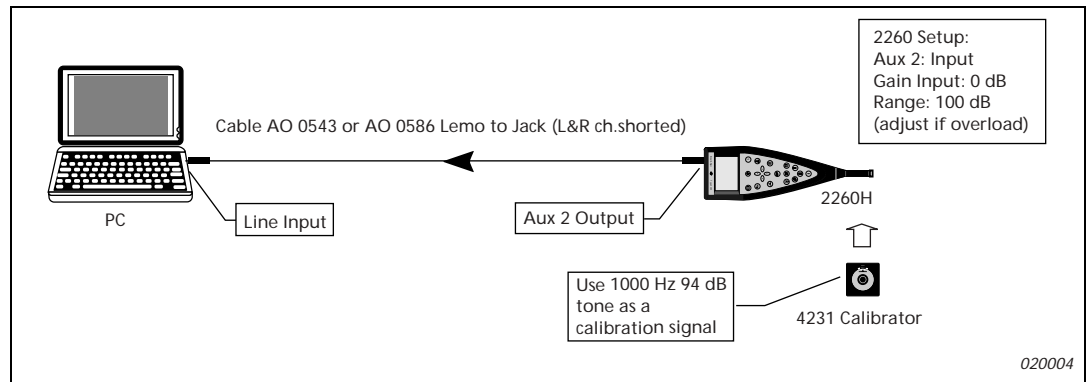
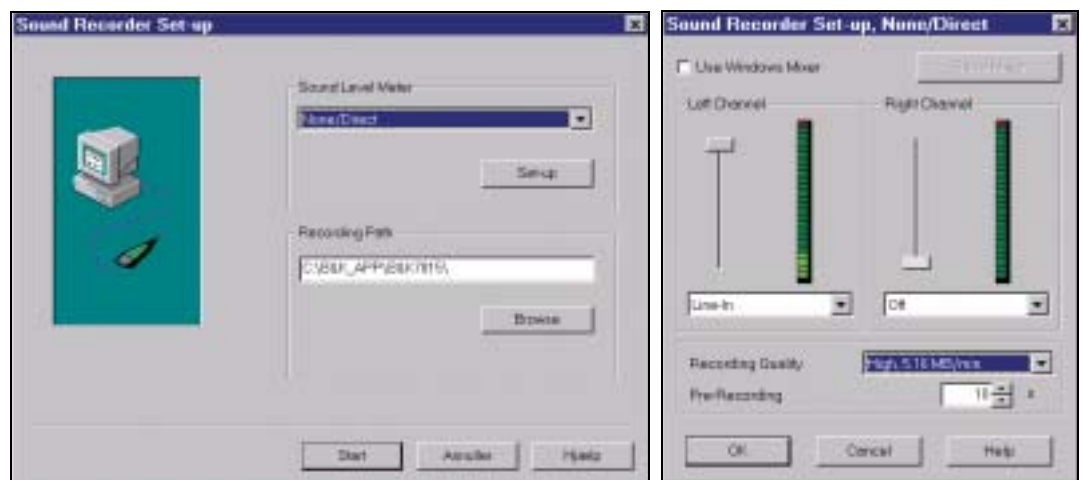

Fig. 27

Left: Tools/Sound Recorder Setup – select None/Direct and the recording path for the wave files

Right: Tools/Sound Recorder Setup/ Setup – select Channel, Recording Quality and Pre-recording time



1. Select Tools/Sound Recorder.../Sound Level Meter/ and then select None/Direct and the path where you want the sound recording .wav files to be saved.
2. Click the Setup button and adjust the audio channel, Recording Quality and Pre-Recording as required.
For the audio channel, please follow the Help instructions on Sound Recorder.
For the Recording Quality, Low Quality is OK for listening and identification, while for later analysis, High Quality should be used.
Pre-Recording lets you record sound existing before the instant you initiate the recording, using a buffer in the PC. Thus you can make sure the entire duration of interesting sound gets recorded.
3. Mount the 4231 Calibrator on the 2260 H microphone and turn it on. Adjust the level slider on the PC screen so that the displayed green column is 2 divisions below the red indicator.
4. Press OK to return to the Sound Recorder Set-up screen, and press Start. This brings you to the Sound Recorder screen.
5. Set the 2260 range as low as possible without overload, in order to get the best possible signal to noise ratio for the sound recording.

6. In the Sound Recorder screen, press the Start Recording button and notice that the MONITORING message changes to RECORDING and that Start Recording changes to Stop Recording. Also notice the Current File name, which includes the year, date and time for the start of sound recording. The remaining recording time on the hard disk is also indicated.
7. To stop sound recording, press Stop Recording.
8. For more sound recording, repeat steps 5 and 6.
9. When finished, press End.

*Fig. 28
Tools/Sound
Recorder: ready to
start recording*

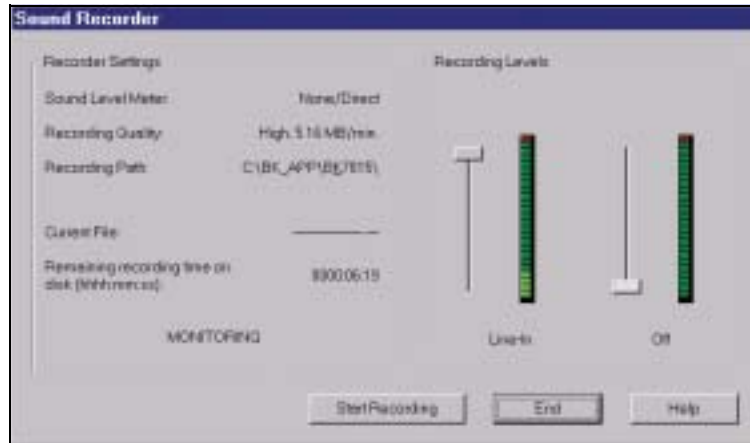

*Fig. 29
Tools/Sound
Recorder/Setup*



Recording Sound on a DAT Recorder

A DAT recorder is useful to record the signal for documentation and later listening or further analysis. The Sony TCD-D8 and TCD-D100 are compact and economical solutions, but more professional-type recorders are also available on the market.

The recommended setup for the TCD-D8 is shown below – the setup for other recorders is similar.

Fig. 30

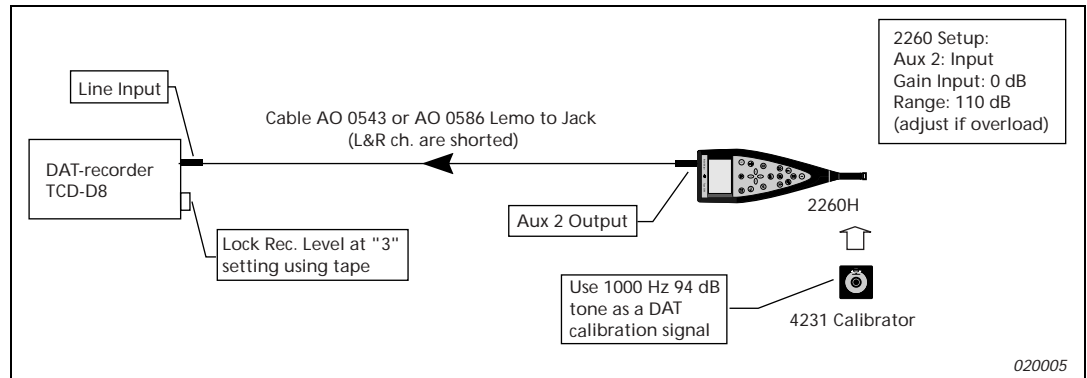

Recording Sound on a PC from DAT Recordings

You can either

1. Use a similar procedure to that described above in the Recording Sound on a PC section

or

2. To get sound recording on your PC with markers, playback and annotation facilities, you need:
 - (a) 2260 with the BZ 7201/02/06 Sound Analysis Software
 - (b) a PC with 7820 Evaluator software

The procedure is the following:

1. Connect the DAT output to both of the 2260 AC inputs (Note 1)
2. Change the application in Type 2260 to BZ 7201/02/06 Sound Analysis Software
3. Use the setup for sound recording on a PC using the Evaluator 7820 PC software
4. Set the Type 2260 input to AC
5. Use the markers in the 2260 Profile display to control the PC sound recording

Note 1: In the BZ 7201/02/03/06, the Microphone1 signal is switched into both Ch1 and Ch2 of the analyzer in order to utilize both channels of the analyzer input (Ch1, C or Lin weighted; Ch2, A-weighted). There is no switch to connect the AC1 and AC2 inputs to the analyzer Ch1 and Ch2, so for the software to work fully (including calibration), AC1 and AC2 must be connected externally. Use two AO 0440 Lemo to BNC cables and a BNC "T" to connect the two channels, and a jack to BNC cable to connect to the DAT.

Playing Back Sound into Type 2260 H

If you have recorded the sound signal on a DAT, or you have it as a wave file on a PC, you can play it back into Type 2260 H for analysis.

For Type 2260 H, only connection to AC1 is needed.

Fig. 31

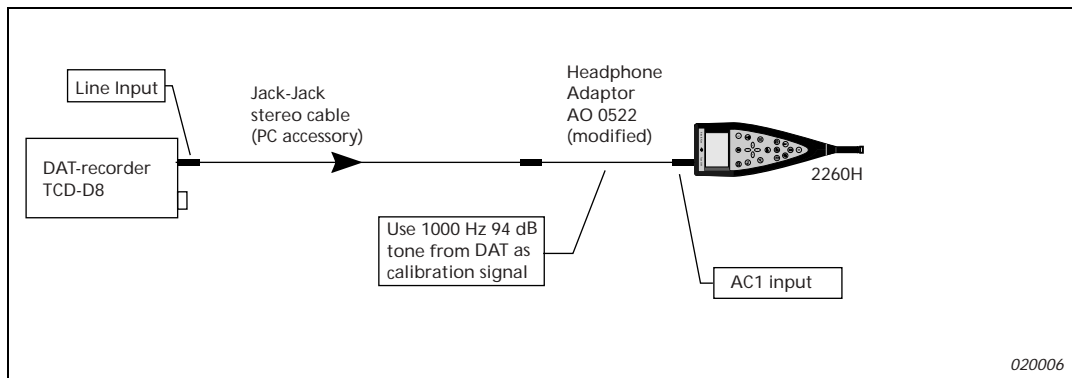

The cable used for recording (AO 0543 or AO 0586) has the left and right channel shorted in order to give recording on both channels. If the same cable is used for playback, the outputs of the DAT (or PC) will be shorted, which is not recommended. Instead, use the AO 0522 Headphone Adaptor. This adaptor has a shorting link between the left and right channel at the jack socket. Cut this link and connect the adaptor to the DAT or PC using a standard jack-jack stereo cable. Cable AO 0522 can still be used for its original purpose, but of course with a headphone signal only in one channel. (After cutting the link, you may have to change the connection to get the right or left channel as needed).

To calibrate your measurements, perform a calibration using the recorded calibration tone instead of a Sound Level Calibrator.